

# Sash Replacement

## for Andersen® 200 Series Gliding Windows



### IMPORTANT

Read all instructions carefully before attempting this procedure. If you have any questions about your ability to complete this procedure, call Andersen at 1-888-888-7020 for further direction. Andersen WindowCare® service center hours are Monday through Friday, 7 a.m. to 7 p.m. Central Time and Saturday, 8 a.m. to 4 p.m. Central Time. Thank you for choosing Andersen® products.

### Important Safety, Assembly, and Installation Information

Every assembly and installation is different (windloads, structural support, etc.), and Andersen strongly recommends consultation with an Andersen supplier or an experienced contractor, architect, or structural engineer prior to the assembly and installation of any Andersen product. Andersen has no responsibility in regard to the post-manufactured assembly and installation of Andersen products.

#### ⚠ WARNING

Use of ladders and/or scaffolding and working at elevated levels may be hazardous. Follow equipment manufacturer's instructions for safe operation. Use extreme caution when working around window and door openings. Falling from opening may result in personal injury or death.

#### ⚠ WARNING

Improper use of hand or power tools could result in personal injury and/or product damage. Follow equipment manufacturer's instructions for safe operation. Always wear safety glasses.

#### ⚠ WARNING

Weight of window and door unit(s) and accessories will vary. Use a reasonable number of people with sufficient strength to lift, carry, and install window and door unit(s) and accessories. Always use appropriate lifting techniques.

#### ⚠ WARNING

Support sash during removal and reinstallation. Failure to support Sash may result in personal injury, product and/or property damage.

#### ⚠ WARNING

Wear gloves, safety glasses, goggles, and eye shields when handling glass. Failure to do so may result in severe personal injury.

### NOTICE

If any of the below requirements are not met, have a qualified carpenter, builder, or contractor determine whether window frame should be replaced or reinstalled, or if structural problems need correction before sash replacement.

- Check sash size, glass type, color, and kit contents to verify all parts are correct.
- Check unit/sash opening for plumb, level, and square. Measure frame diagonally from corner to corner, distances must be equal within 1/8".
- Inspect for damage to frame and/or bowed jambs, repair if necessary.

**Parts Included**

- (1) Installation Guide
- (1) Sash (Stationary or Passive)

**Tools and Supplies**

- Safety Glasses
- Phillips Screwdriver

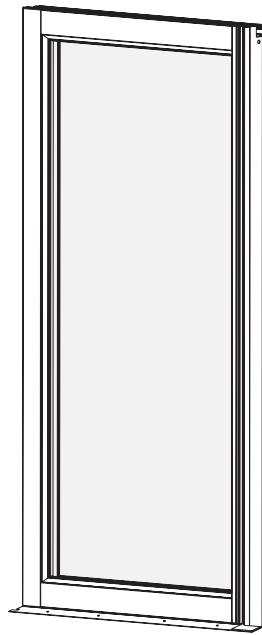

Stationary Sash

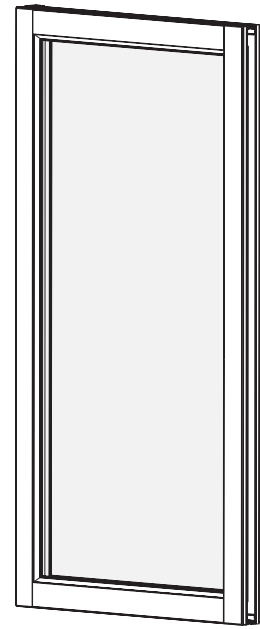

Operating Sash

**1. Remove Insect Screen**

- Open *Operating Sash* to the full open position.
- Remove *Insect Screen*, if present.

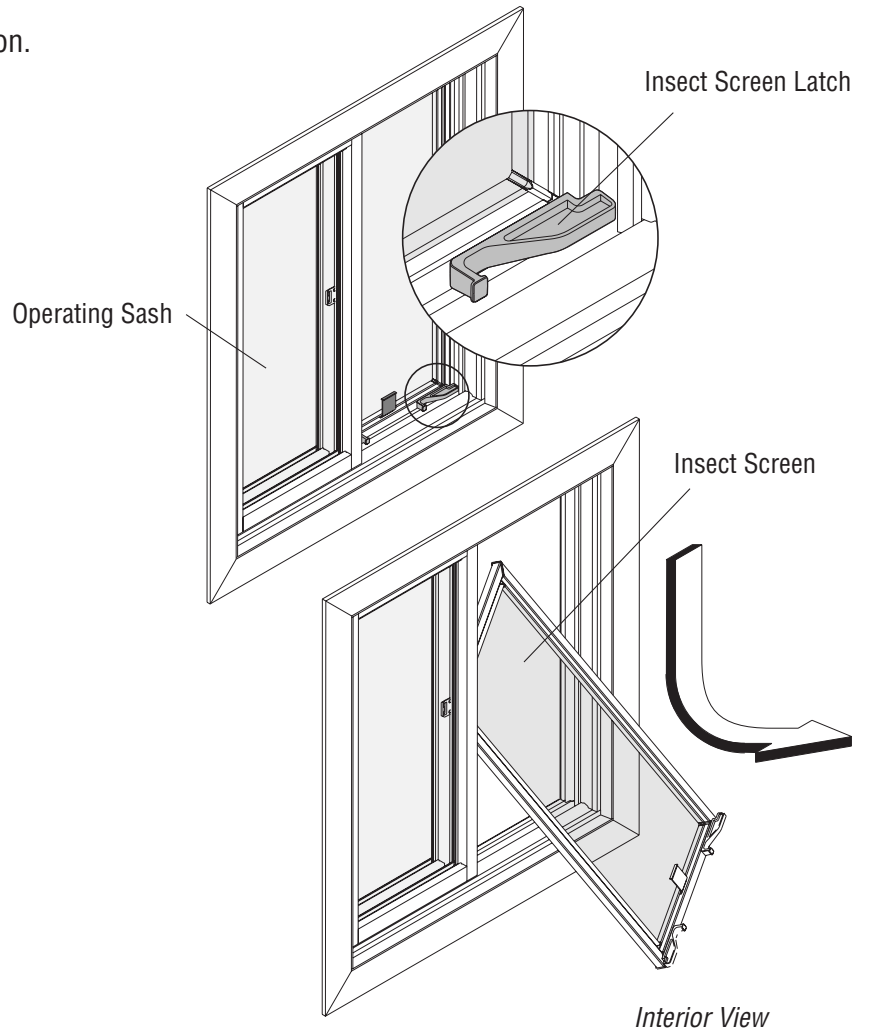

## 2. Remove Operating Sash

### ⚠ WARNING

Sash must be supported during removal and installation. Failure to support Sash may result in personal injury, product, and/or product damage.

### ⚠ WARNING

Use extreme care when working around window opening. Never leave a window opening unattended, especially when children are present. Falling from window opening may result in severe personal injury or death.

### NOTICE

- Operating Filler is a two piece component. Left Operating Filler and right Operating Filler must be removed before removing Operating Sash.
- Retain all removed hardware and screws for reuse.

- Open *Operating Sash* to full open position.
- Remove screws from the right *Operating Filler* from interior. Remove right *Operating Filler*.
- Close *Operating Sash*.
- Remove screws from the left *Operating Filler* as viewed from interior. Remove left *Operating Filler*.
- Open *Operating Sash* using **both** hands and remove by rotating top of *Operating Sash* inward and lift *Operating Sash* off of *Sill Riser*.
- Transfer hardware from removed sash to replacement sash.

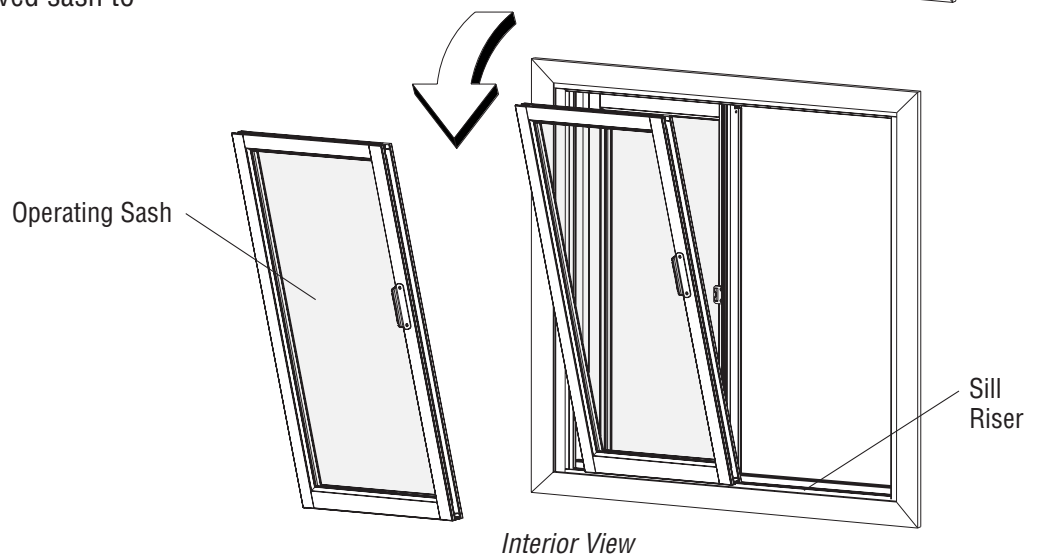
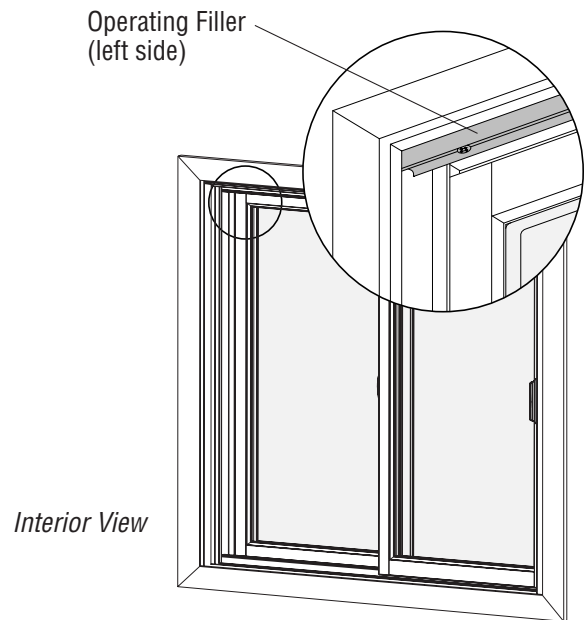
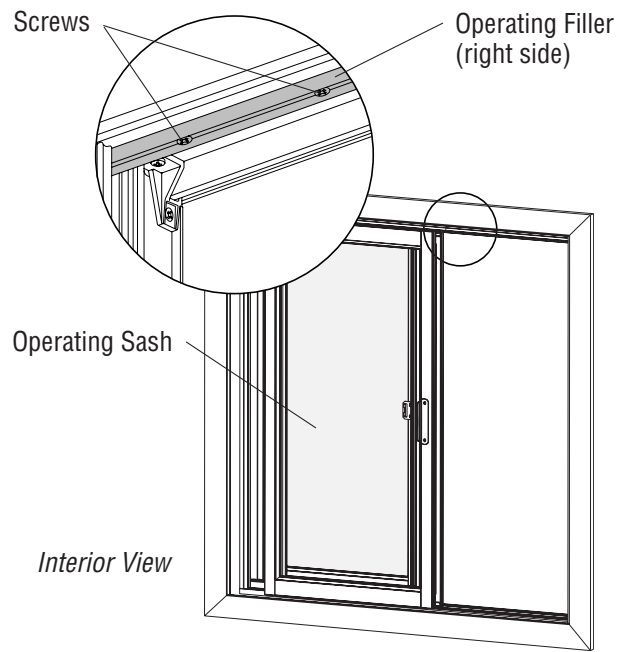

### 3. Remove Stationary Sash

#### ⚠ WARNING

Sash must be supported during removal and installation. Failure to support Sash may result in personal injury, product, and/or product damage.

#### NOTICE

Remove Operating Sash before removing Stationary Sash.

- Remove screws in *Stationary Filler* located at sill of *Stationary Sash*.
- Remove *Stationary Sash Bracket* from upper right-hand corner of *Stationary Sash*.

#### NOTICE

Silicone sealant seal at the lower left hand corner of sash must be broken to remove *Stationary Sash*. Sliding *Stationary Sash* may require extra effort.

- Slide *Stationary Sash* to the right using both hands, breaking the silicone seal in lower left hand corner of sash. Remove by rotating bottom of *Stationary Sash* outward, lower enough to clear head jamb, and lift into interior.
- Transfer hardware from removed sash to replacement sash.

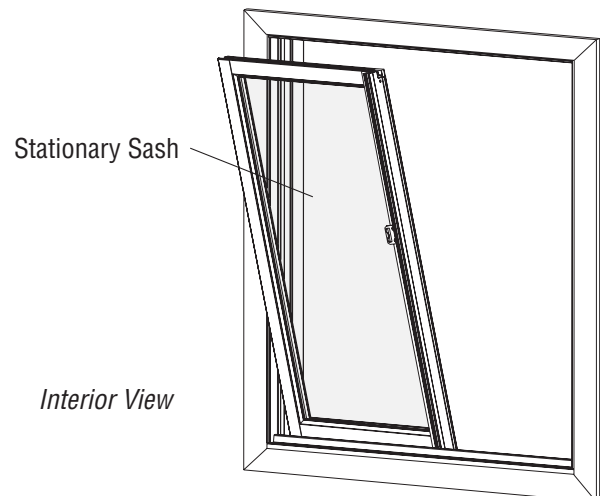
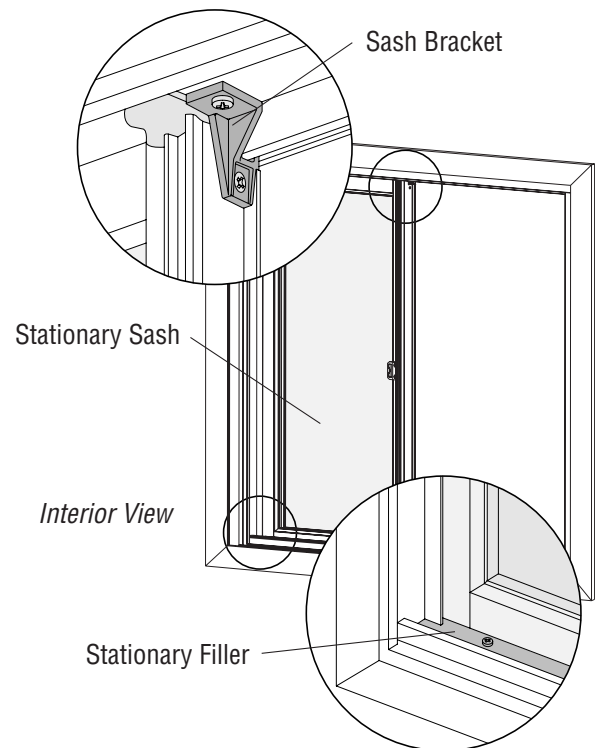

### 4. Reinstall Sash

#### ⚠ CAUTION

**DO NOT** over tighten screws. Stripping of screw holes may occur.

- Remove old silicone sealant from lower left-hand corner of window frame.
- Reapply 3/8" bead of silicone sealant to corner of window frame as shown.
- Apply silicone sealant to screw holes in sill.
- Reinstall *Stationary Sash*, *Operating Sash*, and *Insect Screen* by performing **Steps 1, 2, and 3** in reverse order.

